

4700 Sliding Installation Guide





INSTALLATION GUIDE

IMPORTANT

The purpose of this guide is to ensure the highest quality standards in the installation of the **4700 Sliding**.

Before starting the process, it is necessary to review all the steps to ensure that there is no loss of performance in the installation process.

The installation must be carried out and supervised by duly trained and qualified professionals.

Preparation

Tools:

No special installation tools are required.

It is important to ensure good leveling and plumbing of the door, whether it is due to irregularities of the support surface of the frames or if it is due to possible deflections of the structures that will support the weight of the system, in order to be sure the system works correctly and it does not appear anomalies in the rolling of the leaves.

Make sure that the building never transmits loads to the door.

Opening Possibilities

Fixed and sliding opening

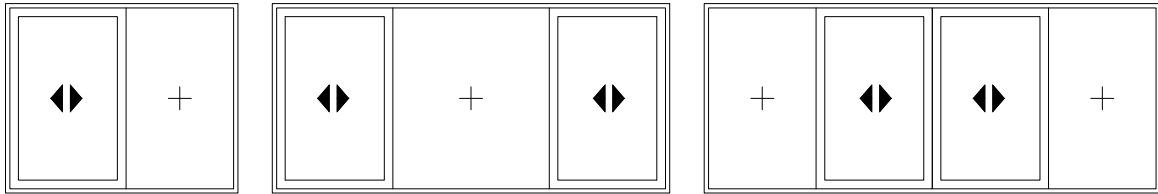

Sliding opening

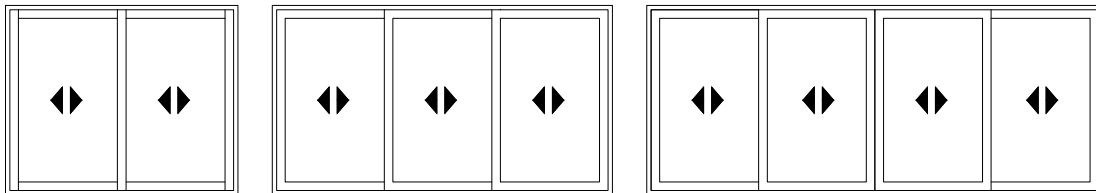

Three rail frame

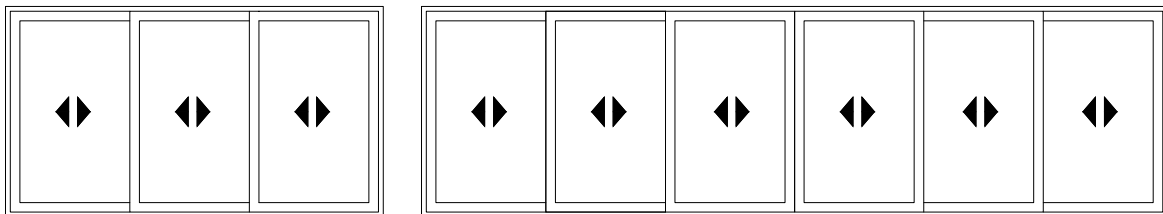

Galandage opening

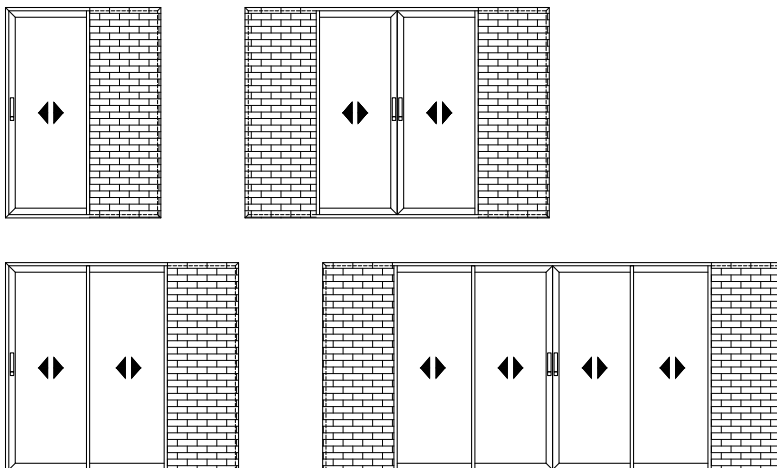

4700 Sliding Technical Data

Standard sliding system with straight aesthetic and a reduced interlock section of 47 mm, ideal for closing large spans without using a lift & slide solution, it combines great thermal and acoustic performance with large glazed surfaces of up to 88%.

Transmittance

$U_w \geq 1,1$ (W/m²K)

Please consult typology, dimensions and glazing

Acoustic insulation

Glazing Max. 34 mm / Min. 26 mm
 Maximum Acoustic insulation Rw 40 dB

Sightlines

Sightlines		Profile Thickness	
Frame	115 mm / 120 mm	Balcony	1,5 mm
	185 mm 3 rails		
Sash	50 mm		

Polyamide Strip Length 20 - 25 mm

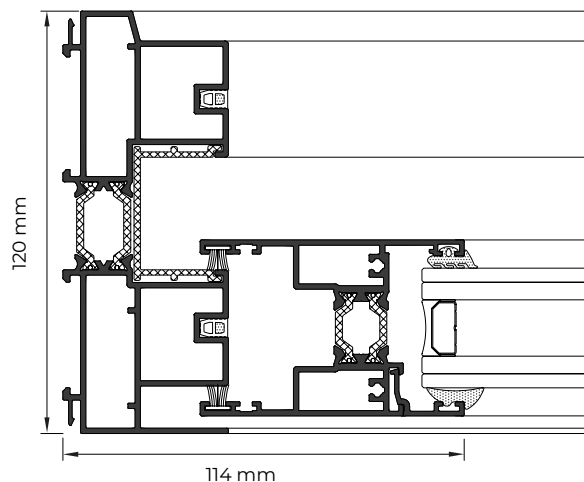

Features

Air permeability	Class 3
Wind resistance	Class C5
Water tightness	Class 7A
Security test	PAS24 <input checked="" type="checkbox"/> PASSED

Reference Test AEV 1,8 x 2,2 m / 2 Sashes

Finishes

Possibility of dual colour systems
 Colour powder coating (RAL, mottled and rough)
 Wood effect powder coating
 Anti-bacterial powder coating
 Anodised

Opening possibilities

Sliding
 1 rail (sash + fixed light)
 2 and 3 rails
 Pocket possibility

Maximum Sash Weight

Width (L) = 2500 mm
 Height (H) = 3000 mm

Consult maximum weight and dimensions according to typologies

Maximum Sash Weight 280 Kg



Installation Guide

Prepare the opening

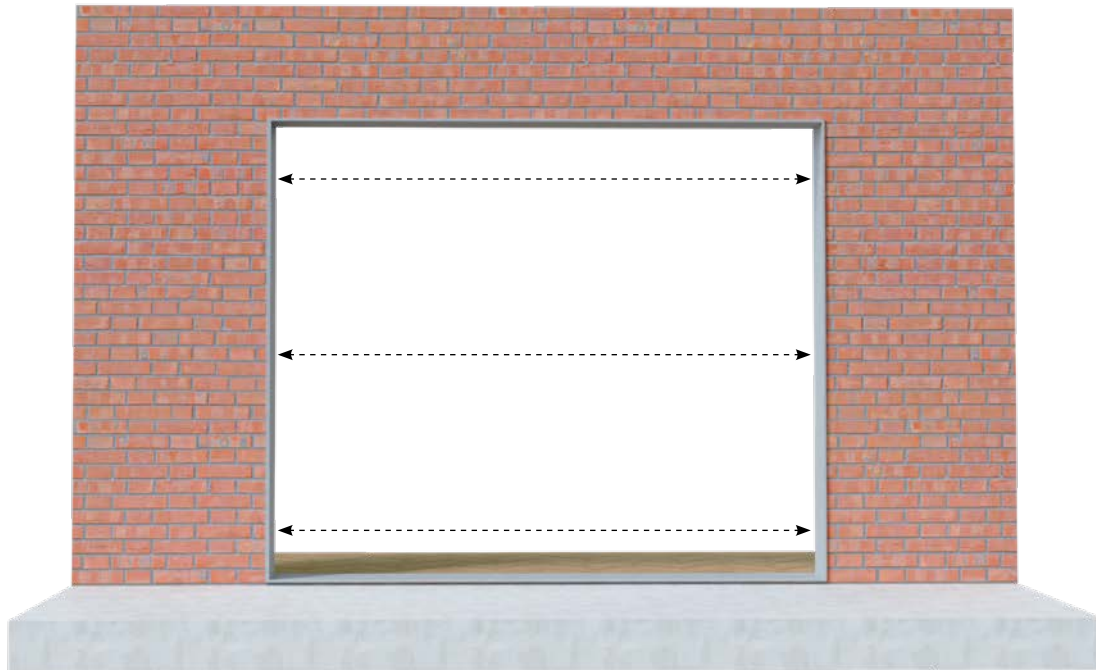

- 1 Measure **widths** and **heights** in several points.

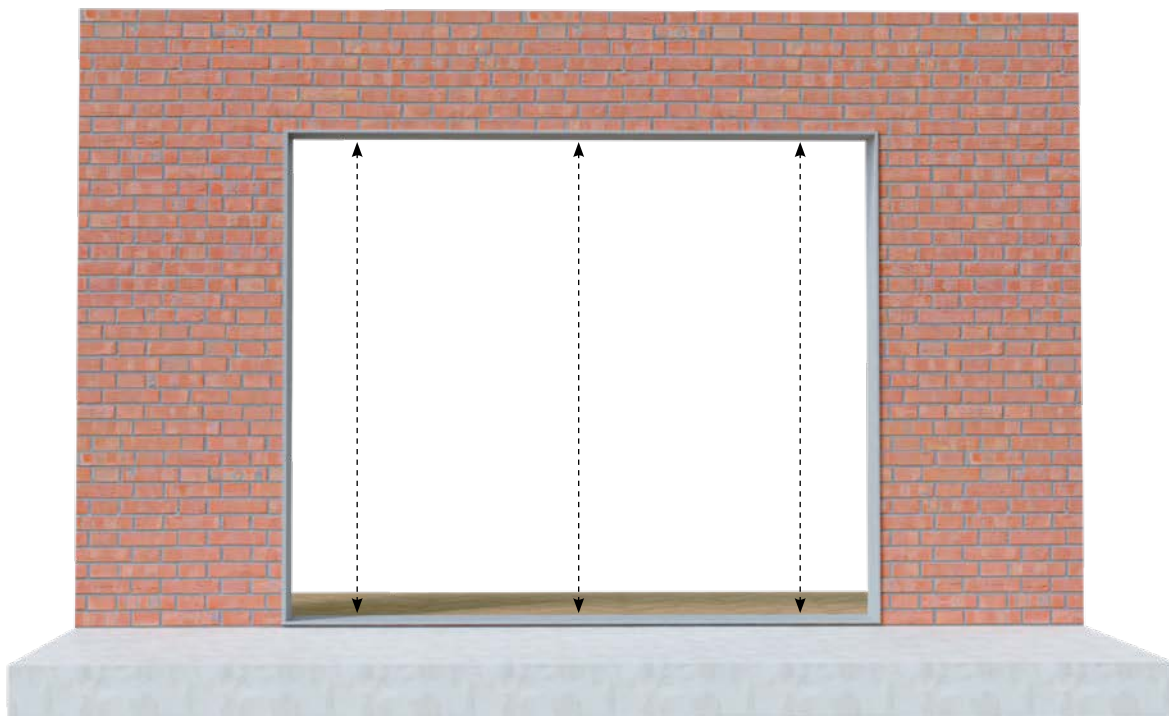

Installation Guide

- 2** **3** Level the threshold in both directions, packing accordingly.

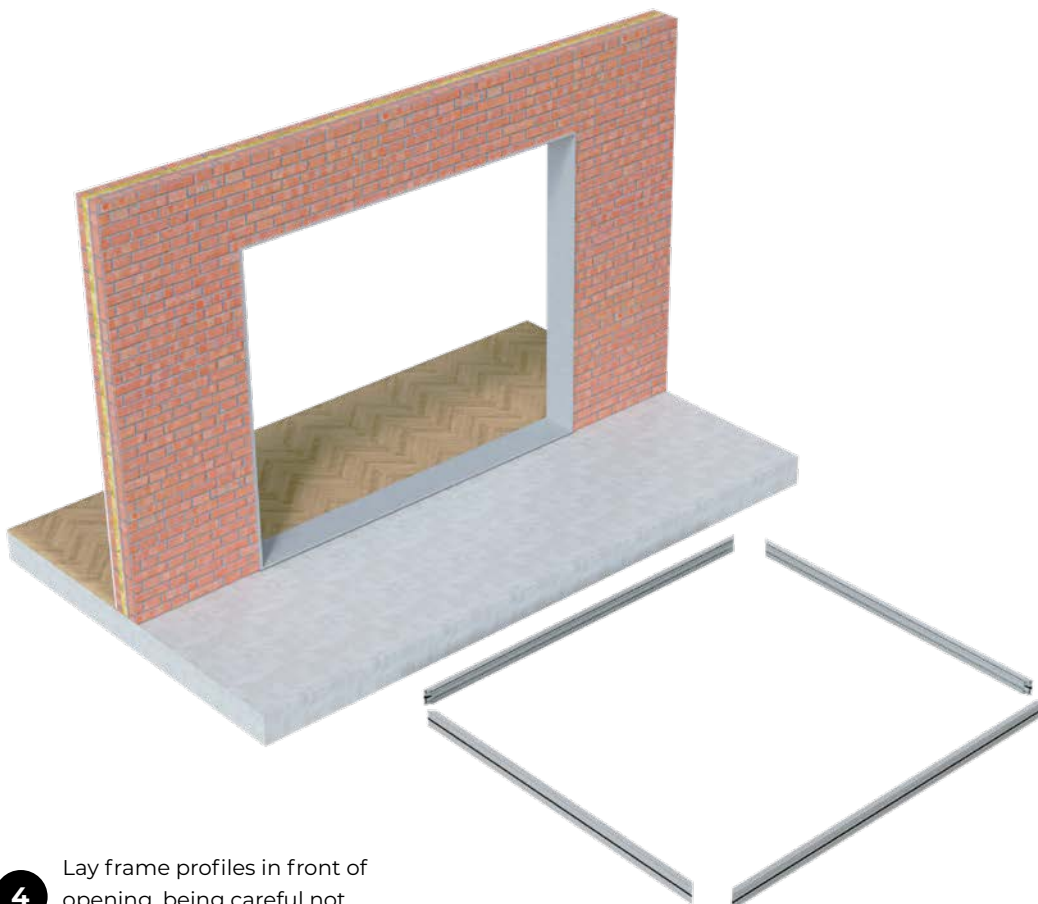
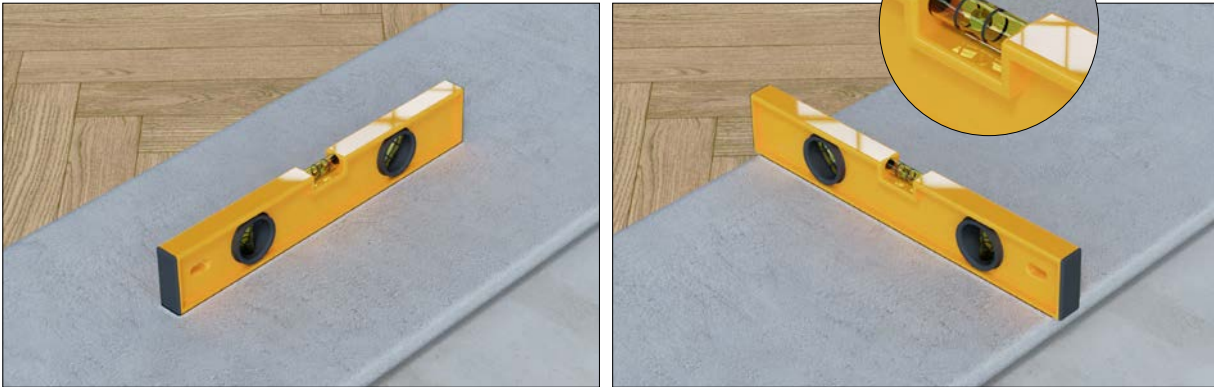

- 4** Lay frame profiles in front of opening, being careful not to scratch the finished.

Installation Guide

Connect the jambs and bottom track



It is important to seal the bottom profile at both ends to prevent water from draining into the cleats.

Installation Guide



Installation Guide

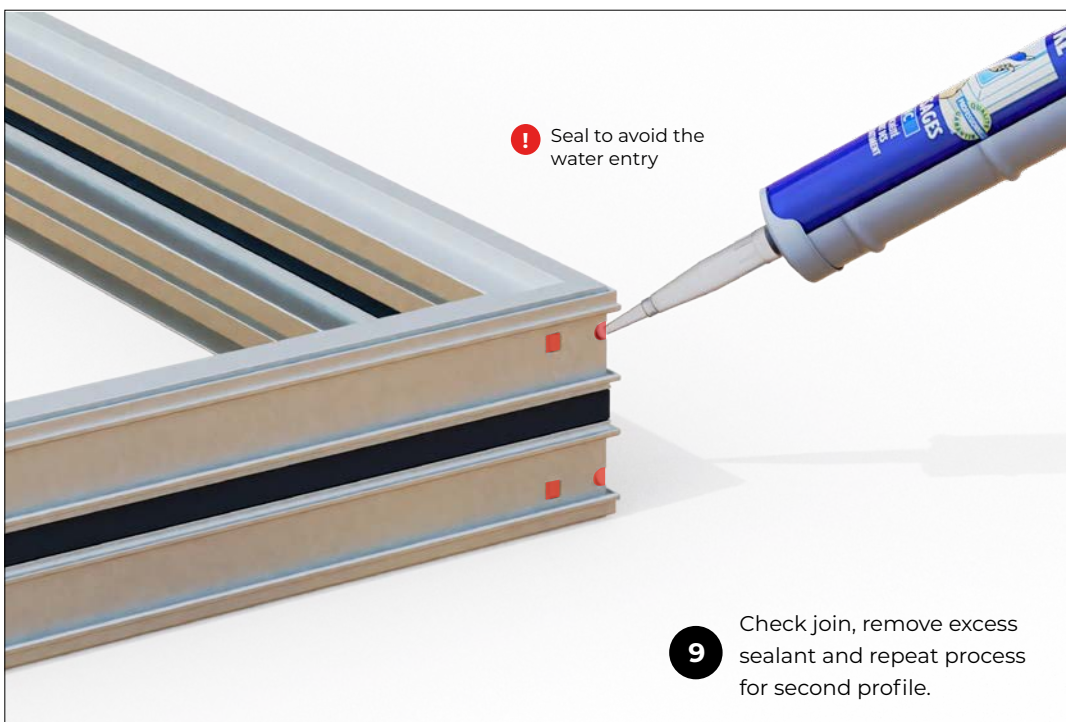
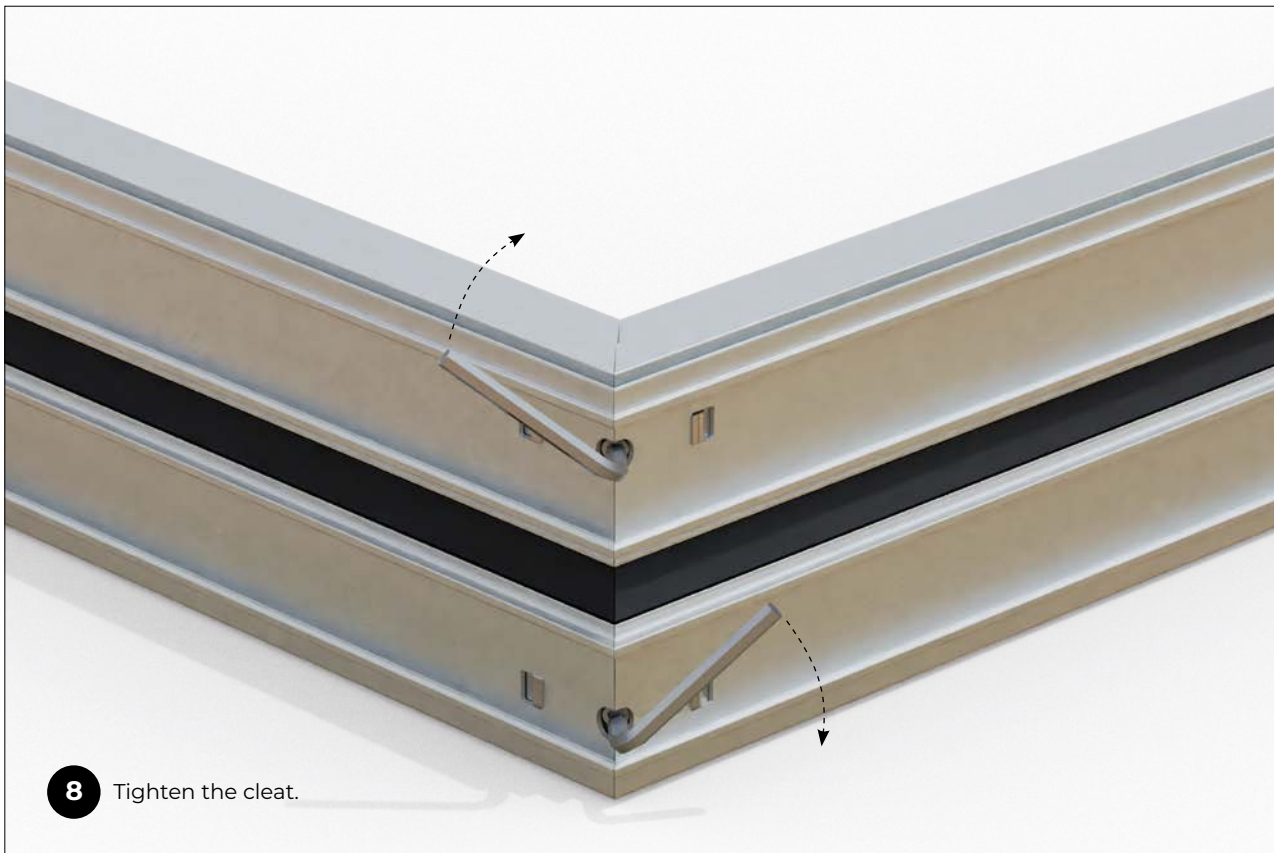

Installation Guide

10 Assemble all frame profiles.



Installation Guide

Fixing the frame to the structure the separation between screws is recommended does not exceed 600 mm. The depth of the fastening on site should never be less than 30 mm. (See table with recommendations for use)

The fixing of the shoe can also be carried out by the use of fixing slugs.

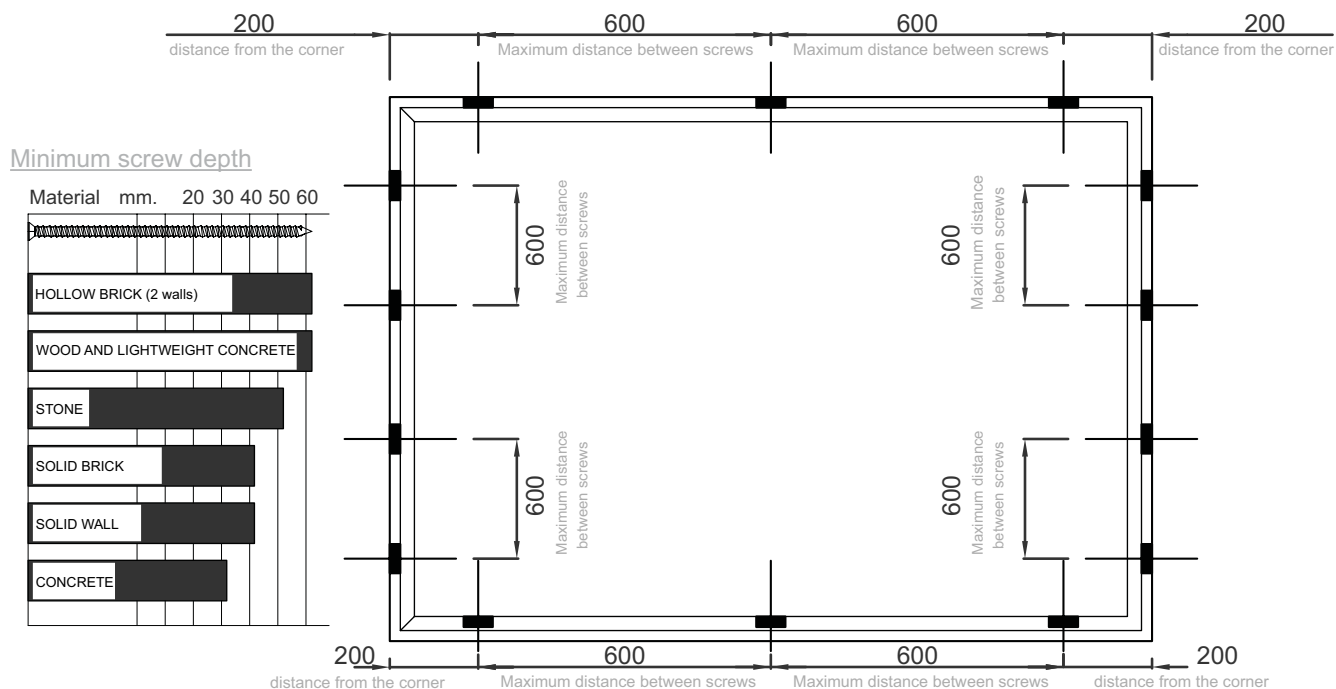

5. Lift the frame into the opening

- 11.1** Lift frame into the opening, ensuring drainage caps are situated externally.

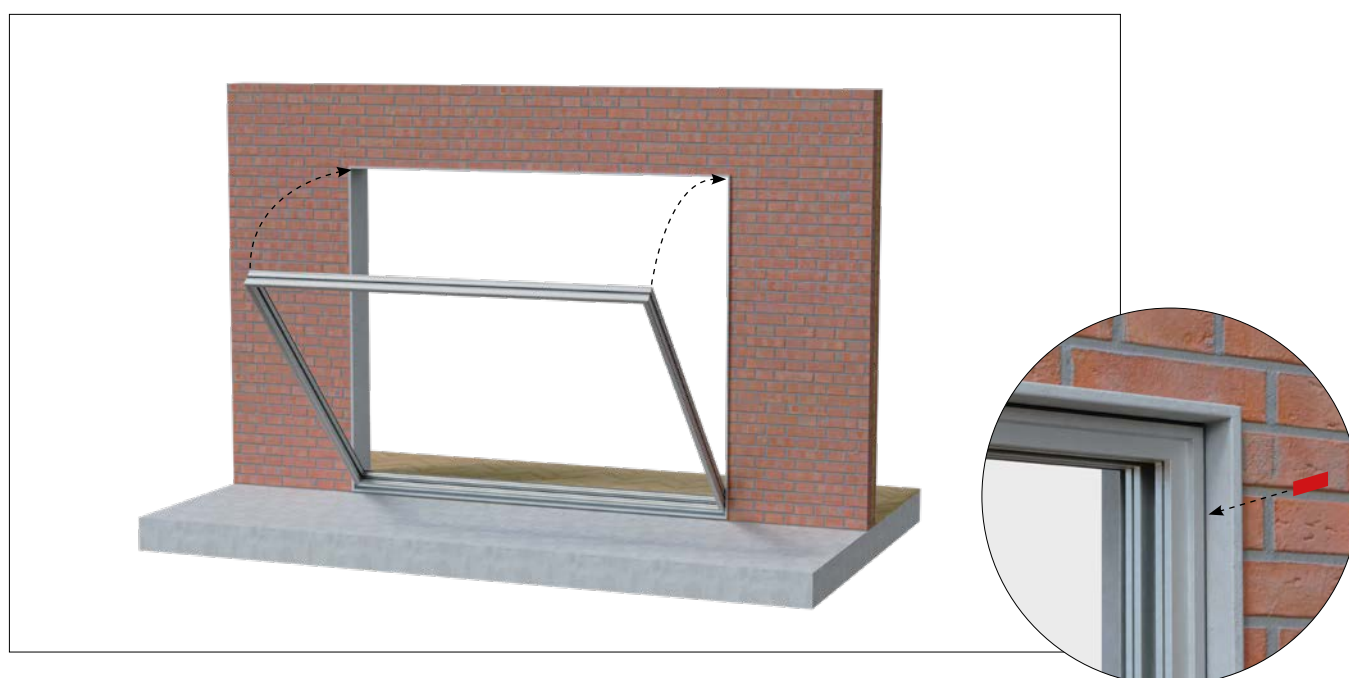

- 11.2** Insert packers above both jambs.

Installation Guide

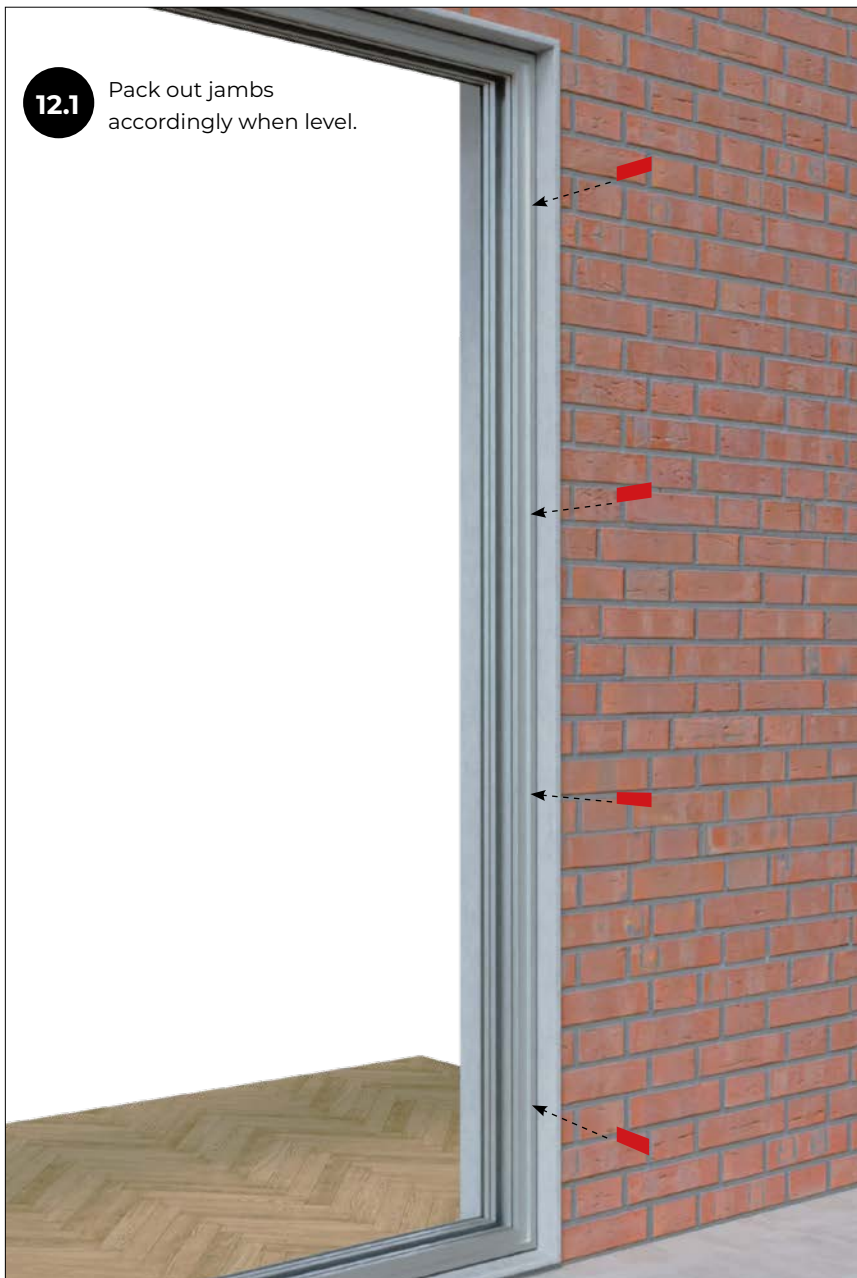

12.2 Pack out across the top track for consistent internal frame sizes. Ensure the track doesn't bow in any direction. Ensure that the building does not transmit any loads into the frame.

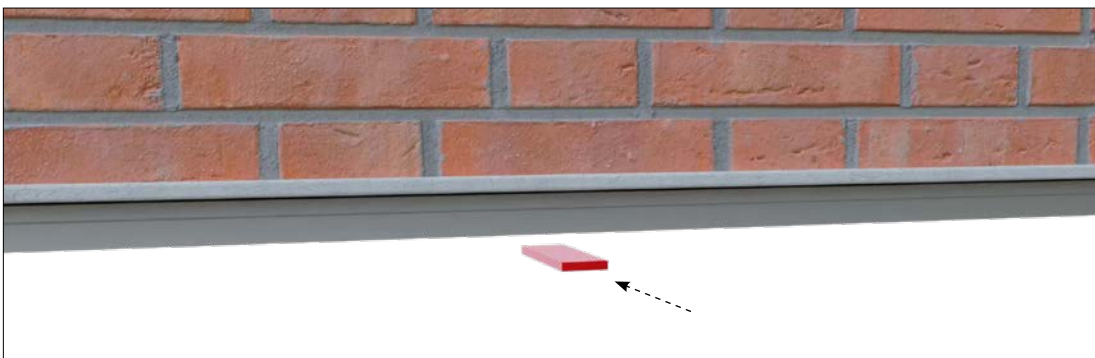

Installation Guide

6. Level and fix both jambs



13 Level out jambs in both directions.

7. Fix the top track



14 Where possible, fixing points should be on both sides of the frame, in a zig-zag pattern.

Installation Guide



- 15** Drill and countersink an appropriate sized fixing hole through the frame. This should be no more than 200 mm from the external corner of the frame.



- 16** Insert suitable sealant to fixing hole, then screw preferred fixing in place. Repeat process along the bottom track, ensuring fixings are within 900 mm intervals.

Repeat the steps "15 and 16" on the four profiles of the frame (horizontal and vertical), so as to properly fix it to the wall.

Installation Guide

- 17** Accurately measure the internal frame dimensions.

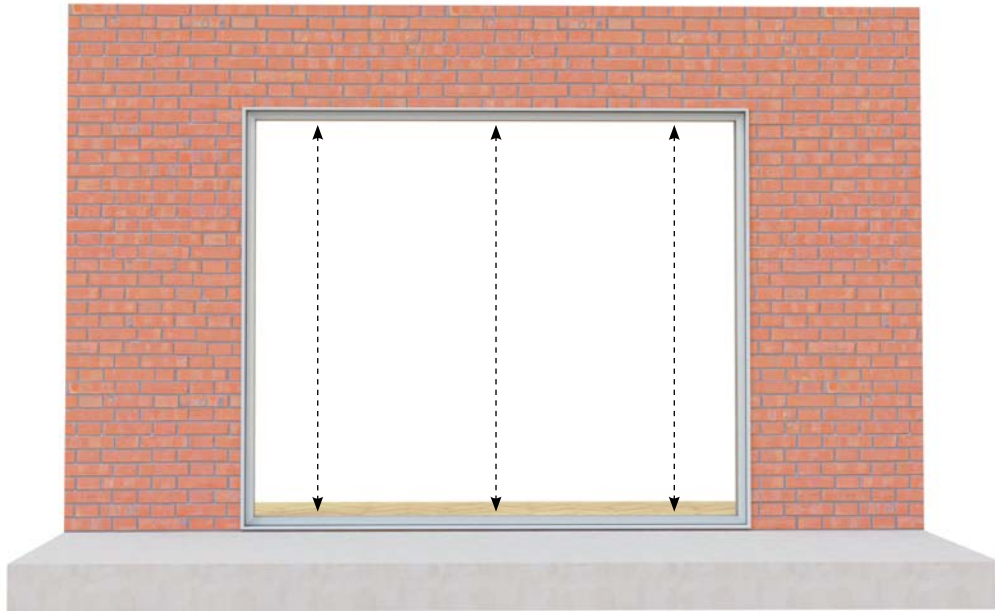

- 18** Measure diagonally from corner to corner to check the frame is square.

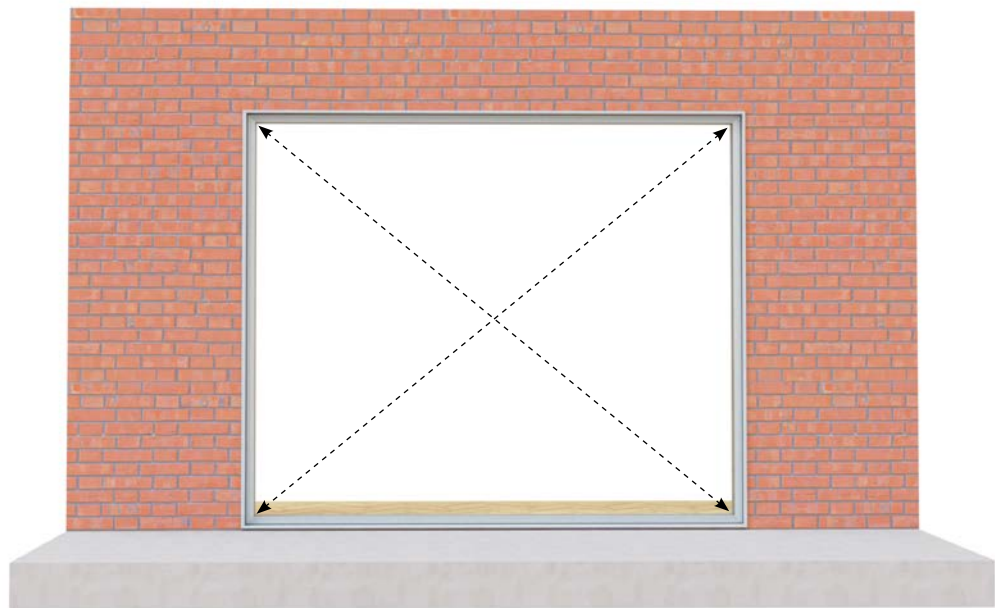

Installation Guide



IT IS RECOMMENDED TO POSITION THE GLAZING PACKERS ACCORDING TO THESE CONFIGURATIONS.

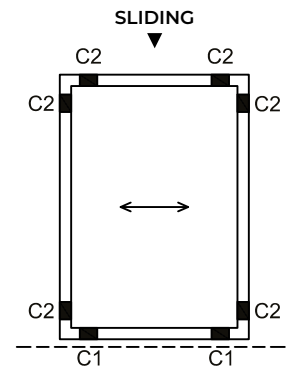
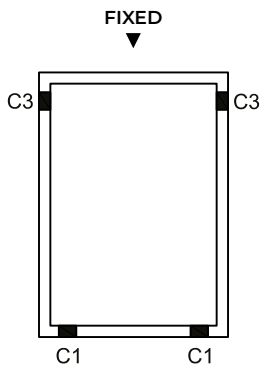

Glazing packers must be placed towards the inside of the bearing points.

Name of the glazing packers:

- C1 = Support glazing packer
- C2 = Perimeter glazing packer
- C3 = Security glazing packer

Notes:

- The glazing packers must be fitted as shown in the sketch shown above, without adding other glazing packers in different positions.
- The distance between the axis of the glazing packers and the edge of the glass will be approx. $L/10$ (L = length of the glass).

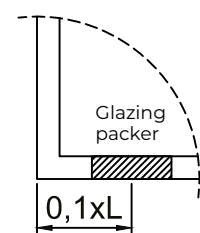

Installation Guide

- 20** Insert the glass into the sash.

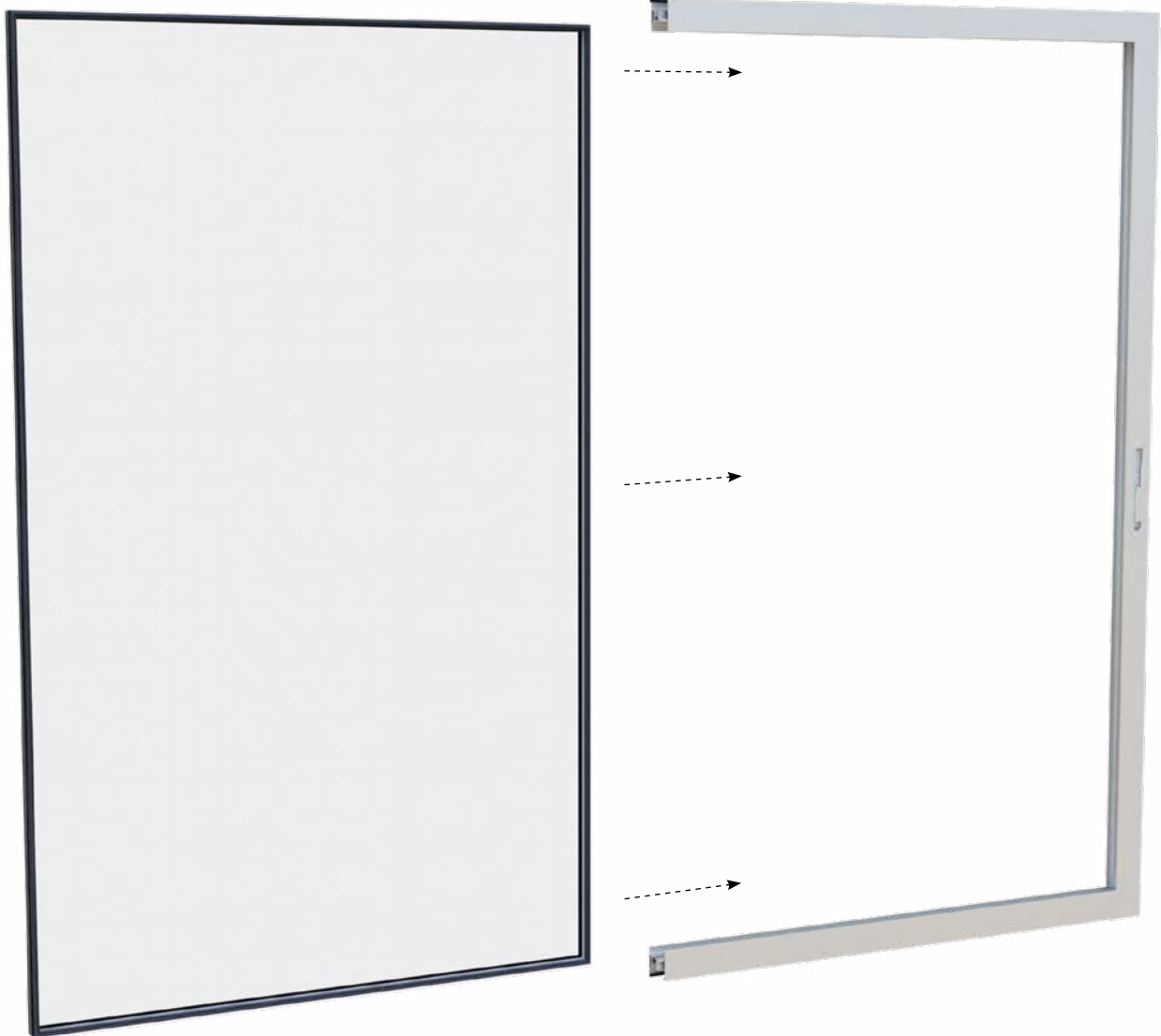

Installation Guide



IMPORTANT: Avoid direct contact between EPDM joints and structural silicone.

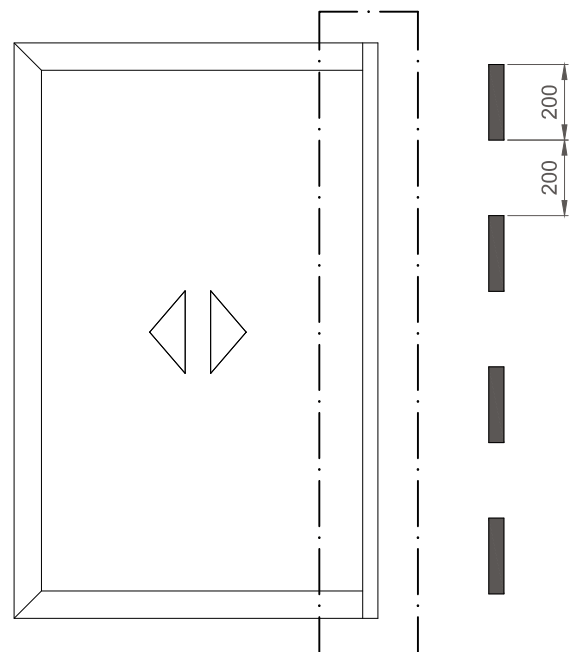
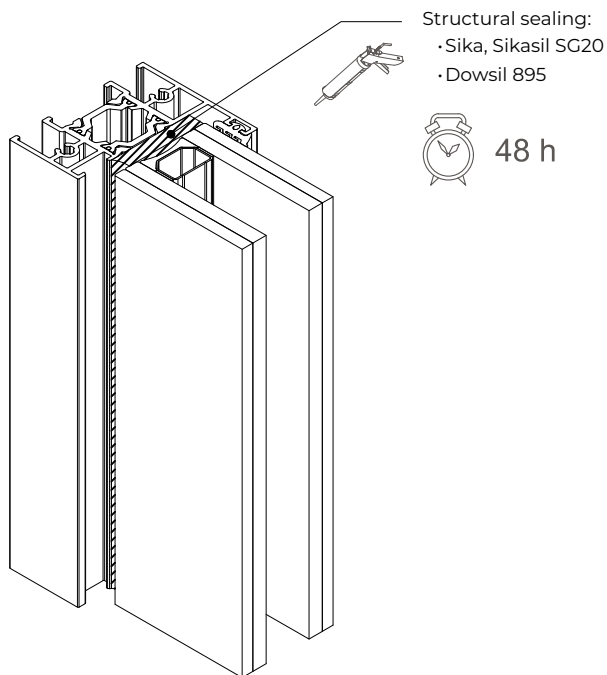

Installation Guide

22 Assemble the interlock side.

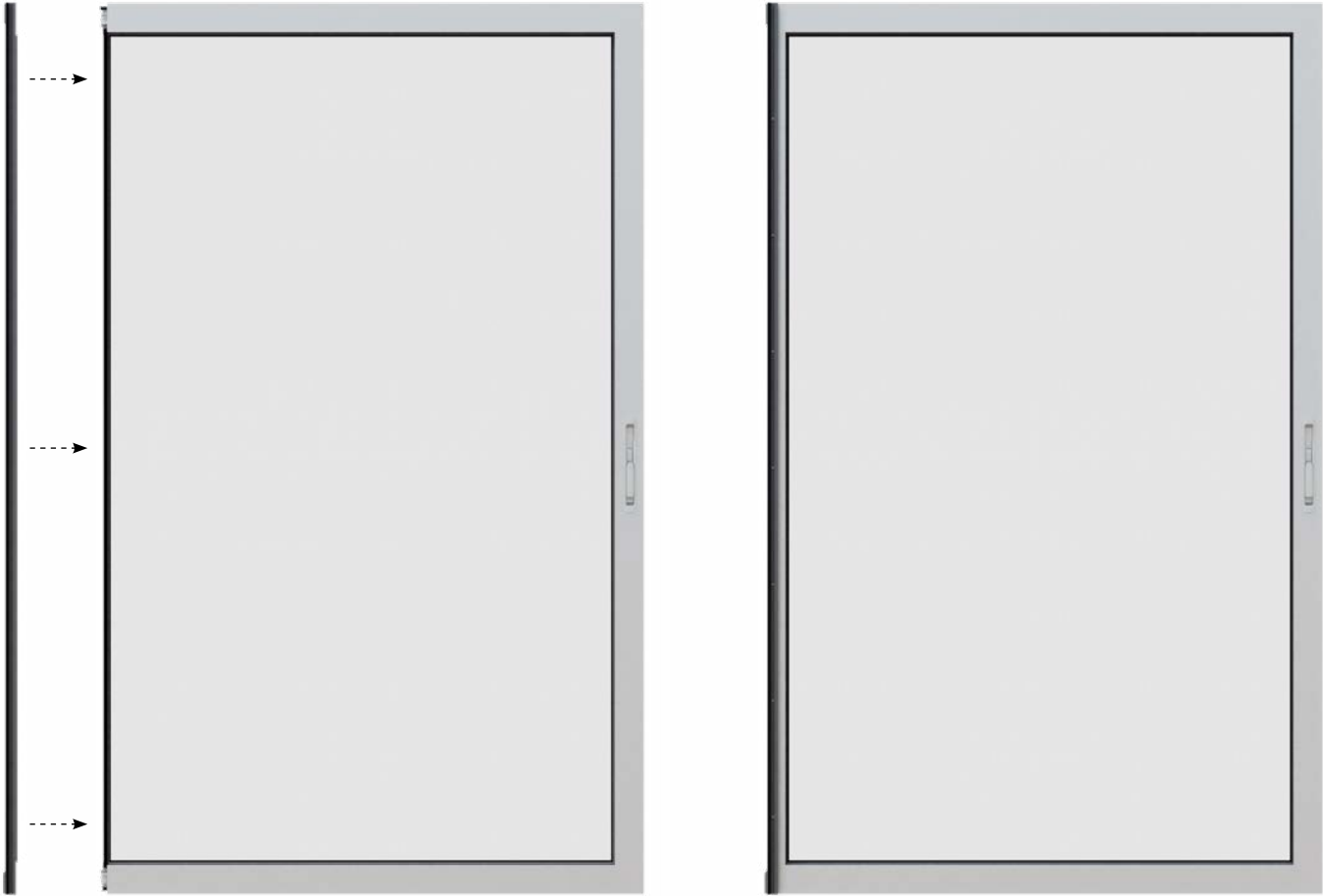

Installation Guide



Installation Guide

- 3** Insert top of sash into top track channel.



- 4** Swing bottom of sash above running gear.

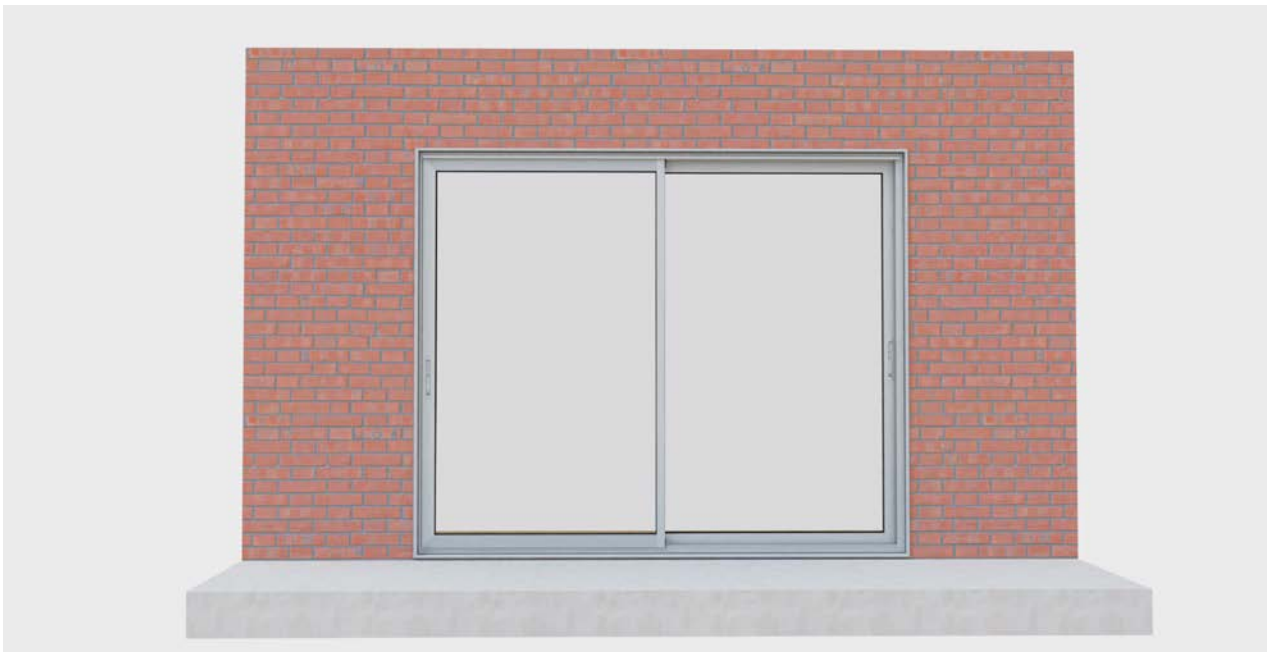
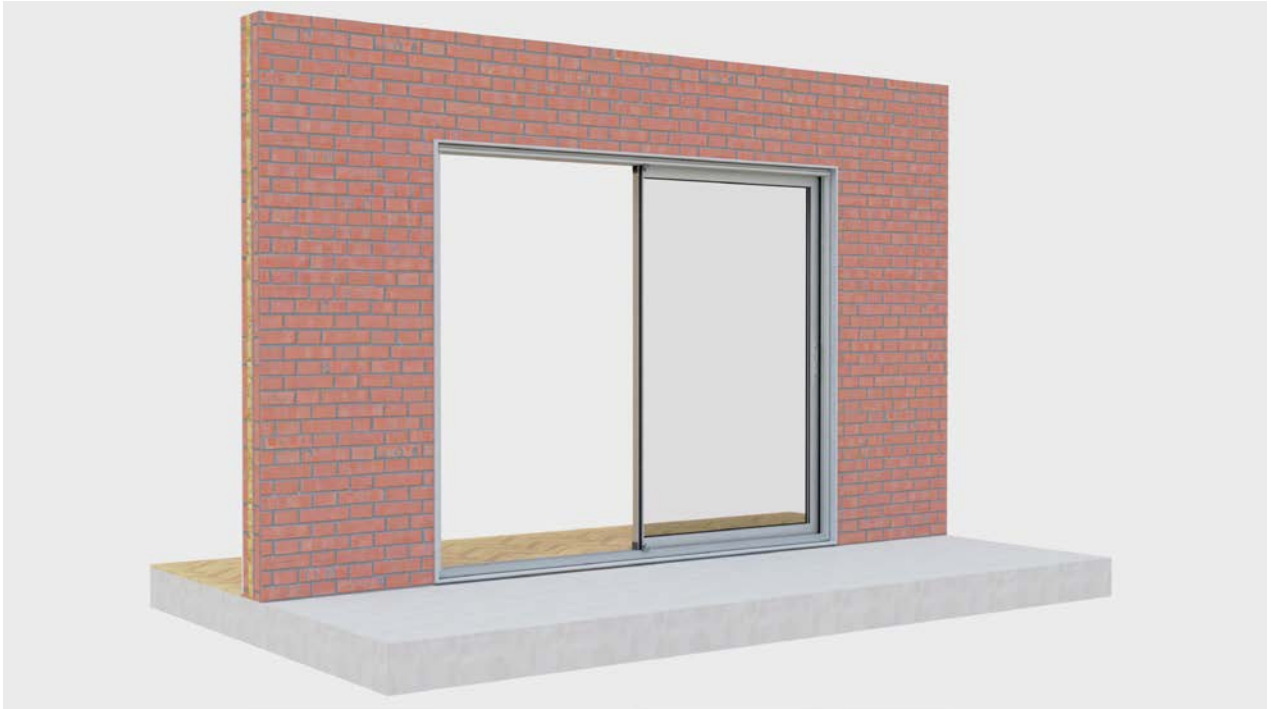

The logo consists of two overlapping rounded squares. The front square is a darker blue and contains a white letter 'G'. The back square is a lighter blue and is partially obscured by the front one.

Glass Openings

4700 Sliding Installation Guide
